



FT7RP

Features

- ◆ RP Tweeter
- ◆ 8 ohm impedance
- ◆ 3kHz to 45kHz frequency response
- ◆ 93dB sensitivity at 1W/1m (3.3ft)
- ◆ 0.155kg (0.34 lb) net weight



Specifications

Impedance	: 8 ohm
Reproduction Frequency Response	: 3kHz - 45kHz
S.P.L.	: 93dB/W (m)
Music Power	: 80W
Recommended Cross-over Frequency	: more than 3.5kHz
Magnet Weight	: 27g (0.06 lb)
Net Weight	: 155g (0.34 lb)

Frequency Response / Impedance

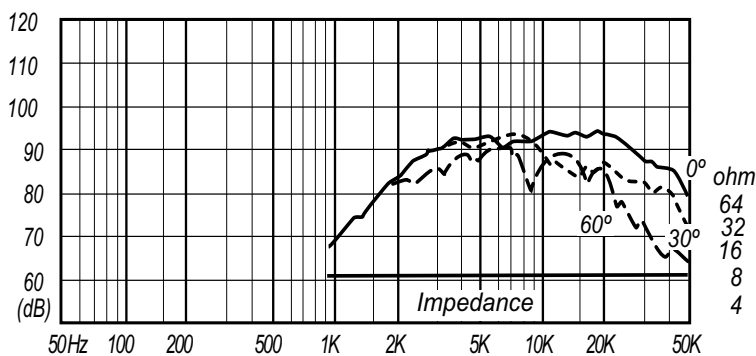

Configuration Example

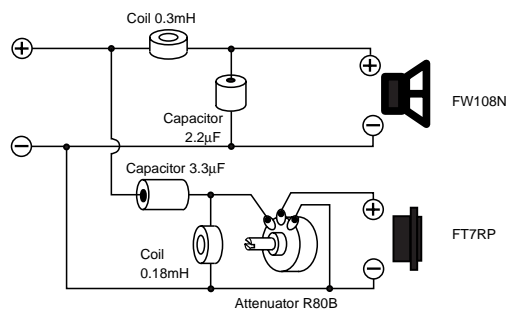

Dimensions & Mounting Information

